



DURAN
electrónica

DURPARK & DURPARK Mini

2-WIRE CO AND NO₂ TOXIC GAS DETECTION CONTROL PANEL

Installation and user manual

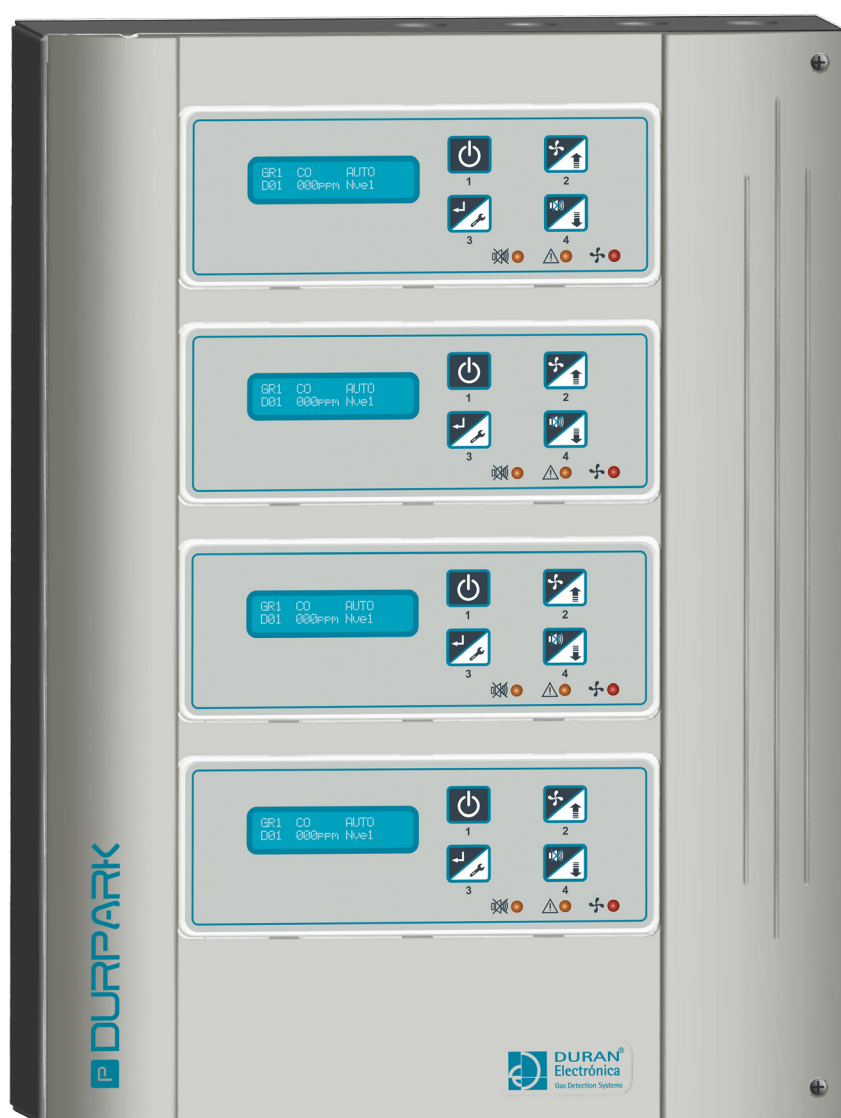

LIST OF COMPATIBLE PRODUCTS



DURPARK mini control panel 1 MODULE LINE



DURPARK 1 ZONE Module line



2 WIRE DURPARK CO detector



2 WIRE DURPARK NO₂ detector

REPLACEMENTS:

Module line

3.7A power source for DURPARK control panel

1.6A power source for DURPARK mini control panel

Power control module

	page
1. INTRODUCTION	4
2. PREVIOUS CONSIDERATIONS	5
3. OPTICAL INDICATIONS.	6
4. PROGRAMMING DETECTOR NUMBER.	7
5. DETECTOR NUMBERING DEPENDING ON NUMBER OF GROUPS	7
6. FACTORY DEFAULT CONFIGURATION FOR THE VARIOUS STANDARDS AND RELAY OUTPUTS ...	8
7. DISPLAY INFORMATION WITH A DISCONNECTED MODULE LINE.	8
8. KEYPAD FUNCTIONS WITH A DISCONNECTED MODULE LINE	8
9. LANGUAGE CHANGE	9
10. LINE TEST	9
11. SYSTEM PROGRAMMING, (ENGINEER MODE, MODULE LINE OFF)	9
12. DURPARK CO-NO ₂ DETECTOR CALIBRATION	11
13. RECOMMENDED PATTERN GAS AND GAS FLOW FOR CALIBRATION.	12
14. INTERPRETATION OF THE DISPLAY IN TEST MODE FOR CO SENSORS	12
15. DETECTOR TEST	13
16. MODULE LINE START-UP	14
17. DISPLAY INFORMATION WITH A CONNECTED MODULE LINE	15
18. DETECTOR LED CODES	15
19. MODULE LINE LED INFORMATION	16
20. KEYPAD FUNCTIONS WITH A CONNECTED MODULE LINE. (USER MODE)	16
21. CHANGE OF VENTILATION MODE	18
22. ACOUSTICS INHIBITION	18
23. MODULE LINE BEHAVIOUR IN CASE OF POWER FAILURE	19
24. MODULE LINE TECHNICAL CHARACTERISTICS	19
25. DURPARK CO-NO ₂ , 2-WIRE DETECTOR, TECHNICAL CHARACTERISTICS	20
26. DURPARK DETECTORS GENERAL CONNECTIONS. 2 WIRE	21
27. PARALLEL CONNECTION OF CO AND NO ₂ RELAYS TO A SINGLE ACTUATION	22
28. WARRANTY	23

1. INTRODUCTION

DURPARK has been designed for the detection of up to two different gases, CO and NO₂, simultaneously in the same module line. Specially suitable for use in car parks, machine shops, garages and small installations in general.

Expandable from one to four zones and capable of controlling up to sixteen detectors per module line, by a three wire connection, up to a distance of 400/500 meters. It includes three voltage free relay switching outputs, Vent1, Vent 2 and Alarm, and therefore up to three programmable, independent actuating levels in each module line.

Each module line can be programmed to work according to Spanish (one ventilation speed) or Portuguese (two ventilation speeds) standards. When working with Spanish standard, it can be programmed to work with one or two detector groups, allowing for the sectioning of the installation and for each detector group to work with a different activation output.

With Spanish standard, if at the moment of connection the module line recognizes the presence of the two types of gas detectors, CO and NO₂, the module line will reprogram itself automatically to work in two groups and, therefore, with two independent relay outputs, making starting up easier.

Four languages are available to be selected: English, Spanish, French and Portuguese (depending on software version).

Every module line has a capacity to memorize 14 different event types, up to a total of 999 of each type.

Operating individually, each module line includes a backlit 16X2 character lines LCD display plus three optical indicators, internal acoustics and a four key keypad, code protected.

13,8V 3.7A power source, with battery charge, presence and status control for a battery of up to 7.5Ah, plus one general fault dry contact relay output.

Detector operating principle:

Based on an electrochemical sensor that generates a current proportional and linear to the quantity of gas detected.

This signal is suitably analyzed by a microprocessor that, together with ambient temperature data gathered by the detector itself, sends the monoxide concentration data to the module line

A mini version of DURPARK with the same characteristics but non expandable, with one module line and 13.8V 1.6A power source is available.

2. PREVIOUS CONSIDERATIONS



For grid power supply (230 VAC) to the panel, it is recommended to have an independent outlet protected with a 10A bipolar magnetothermal switch.



For the correct operation of the various anti parasitic systems included in the equipment it is necessary to have a good ground connection.



Carry out cabling for the relay outputs through different cable ducts than those of the detection lines.



For the activation of the ventilation motors, contactors controlled by the module line relay outputs must be used, never the relay contacts directly.



Do not drill holes in the cabinet, use the precut holes provided.



To prevent interferences do not install the equipment and/or detectors close to electrical panels, motors or variable-frequency drives.



Do not handle or dismantle any module line, detector or mechanism when the equipment is powered.



In case of any fuse being broken, always use the fuse value indicated in the documentation or in the printed circuit board. Not following these indications could result in damage to the equipment.



The "automatic reset" protection fuses open when they detect a short circuit or consumption increase. If this should happen, disconnect the cables from the control panel terminals, check the cabling, check that the consumption of the elements which it is powering does not exceed fuse capacity and wait for some time until the fuse resets.



We recommend carrying out the installation with 2-wire 3x1.5mm for power supply and communications, and that maximum distance between the control panel and the last detector connected to the line does not exceed 400/500 meters.



Ensure that the connections between the module lines and the detectors are correct. This is done in parallel and any kind of branching is allowed, as long as the position of the negative and positive supply terminals and communications terminal are respected. No resistor needed at the end of the line.





Before connecting the detectors to the module line, make sure that these are disconnected.





Connect the battery respecting the polarity. Red for positive and black for negative.
Only a 12V 7.5Ah battery can be connected, 3,3 Ah for the mini version.

 Although the equipment can work without a battery, we recommend that one be used. If at the moment of module line connection there is no battery present, the module line will reconfigure itself to not check battery state.

 The optimal installation height for CO detectors is 1,8-2m from floor, and its coverage is 200m² (according to Spanish regulations), and for NO₂ 40/50 cm from floor and 100m² coverage, approximately.

 Do not, in any case, exceed the technical specifications described in the manual without first consulting our technical service.

 Do not install the detectors or control panels near a heat source.

 Do not paint the detectors. If you need to paint the area, remove the detectors and cover the detector base.

 If possible, always install the control panels and detectors when all work has been completed in the installation.

3. OPTICAL INDICATIONS

All optical indications are followed by the corresponding identification message in the display unit.

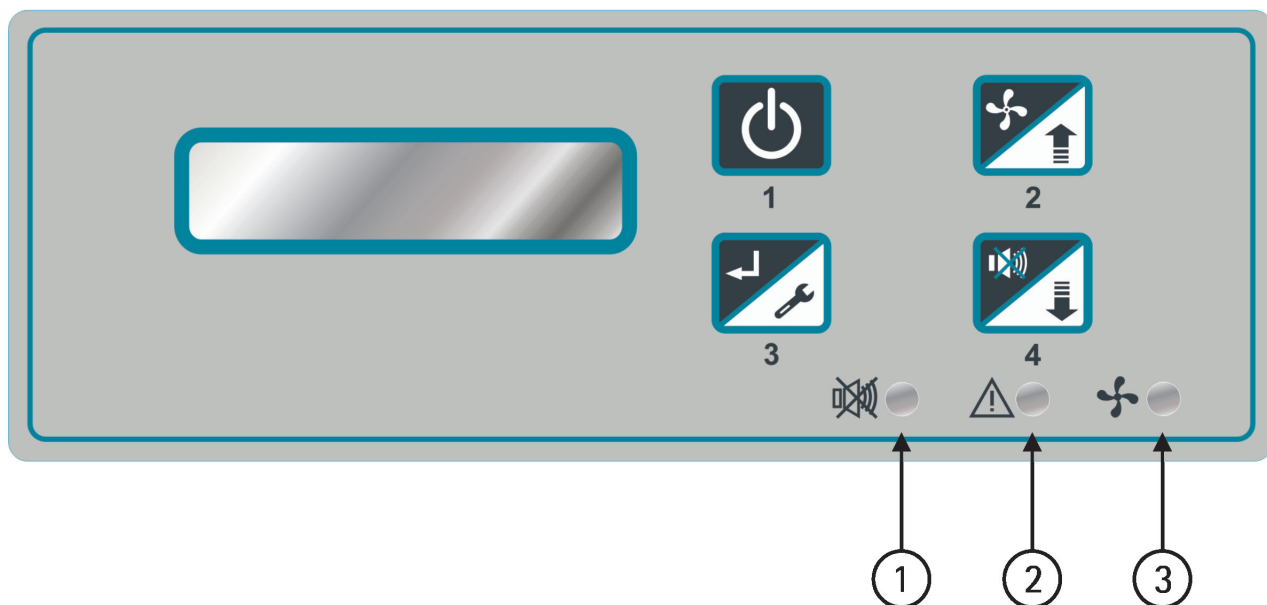

1 Optical indication for inhibited internal acoustics.

2 Optical indication for general fault.

3 Optical indication for ventilation state.

4. PROGRAMMING DETECTOR NUMBER

Detector nr.	1	2	3	4
01	On	On	On	On
02	Off	On	On	On
03	On	Off	On	On
04	Off	Off	On	On
05	On	On	Off	On
06	Off	On	Off	On
07	On	Off	Off	On
08	Off	Off	Off	On
09	On	On	On	Off
10	Off	On	On	Off
11	On	Off	On	Off
12	Off	Off	On	Off
13	On	On	Off	Off
14	Off	On	Off	Off
15	On	Off	Off	Off
16	Off	Off	Off	Off

5. DETECTOR NUMBERING DEPENDING ON NUMBER OF GROUPS

1 GROUP-1 GAS DETECTORS FROM 1* TO 16

2 GROUPS-1 or 2 GASES GR1 DETECTORS 1* TO 8 GR2 DETECTORS 9* TO 16

Always start numbering each group with detector number marked as *. Remember that each group's parameters can be independent, each group being able to detect the same or different gases.

The number of groups is related to the number of ventilation speeds or relay outputs required by each standard. Thus, for example Portuguese standard requires the relay outputs to act on double speed ventilators, therefore two relays being necessary, so its configuration will be fixed to one single group per module line.



If you program two groups, one for CO and another for NO₂, and you do not have available or do not require independent ventilators to engage, the pertinent relay outputs must be connected in parallel (Spanish Standard with 2 groups, see connection example in page 22).

The module which is above the power source is in charge of its management and control. In case of it malfunctioning, control of the power source, battery and grid will stop working, the fault optical indicator will illuminate and the following message will show.

Cont.Mod.Failure

Even in this mode, the module lines will keep functioning with all its functions operational.

6. DEFAULT SETTING CONFIGURATION FOR THE VARIOUS STANDARDS AND RELAY OUTPUTS

Standard	Ventilation ON	Ventilation OFF	Entry delay	Output delay	Alarm level	Group Nr./ Gases	Relay outputs
Spanish 1 gr. Spanish 2 gr.	50ppm	<50ppm	1m	2m	100ppm instantaneous	1/1 gas 2/2 gases	Relays 1 and 2 1 relay per group
Portuguese only 1 group CO	1st Speed 50ppm 2nd Speed 100ppm	1st Speed <50ppm 2nd Speed <100ppm	1m 1m	2m 2m	200ppm instantaneous	1/1 gas per Group	Vent1- Relay1 Vent2- Relay2
Spanish with NO ₂	3ppm	<3ppm	None	5m	10ppm instantaneous		
Portuguese only 1 group NO ₂	1st Speed - 3ppm 2nd Speed - 5ppm	<3ppm <5ppm	None	5m 5m	10ppm instantaneous	1/1 gas per Group	Vent1- Relay1 Vent2- Relay2

With Portuguese standard only one gas may be programmed for each module line.



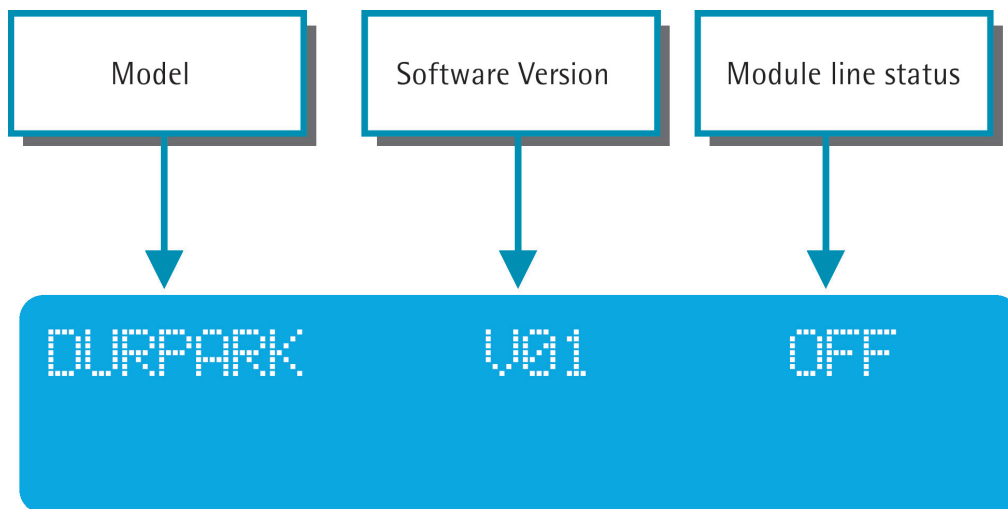

7. DISPLAY INFORMATION WITH A DISCONNECTED MODULE LINE



8. KEYPAD FUNCTIONS WITH A DISCONNECTED MODULE LINE

Each time you need to use the keypad after the symbol  shows up in the display, the engineer code (1111, default setting), must be typed in.

9. LANGUAGE CHANGE

Press  and current language shows up. Insert engineer code (1111, default setting), select language with  or  and press  to save.

10. LINE TEST

This test is particularly useful to verify the type and quantity of installed detectors.

Press , insert engineer code shows up (1111, default setting).

 shows.

Detector 10 CO
*****-----**

the number assigned to the detectors will be shown sequentially, and the type of gas.

⌘ is for all the detectors found and – is for those detectors not found or not installed.

Total 10

Finally the total number of detectors found will be shown.

The test will repeat itself sequentially. To exit this mode press



11. SYSTEM PROGRAMMING, (ENGINEER MODE, MODULE LINE OFF)

If you do not need to modify any parameter, go directly to module line start up in page 14

If you need to change any parameter:



Press 

System Program
Eng. Code

1111 (default setting)

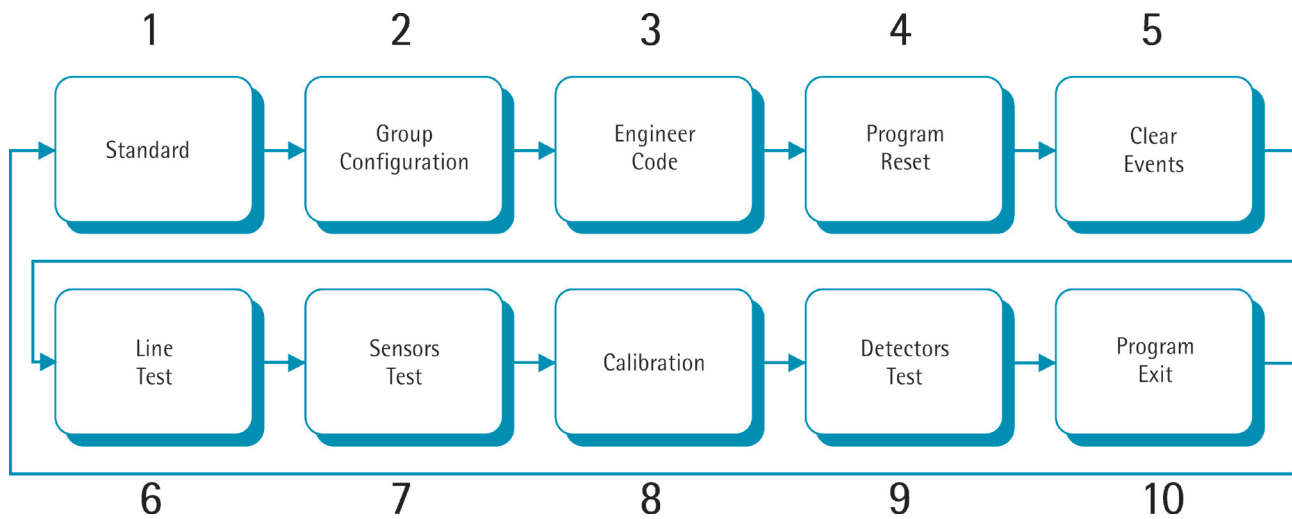
The first menu that shows up is 1, standard.



Press  to advance up to the menu you want and enter by pressing 

To move through the different menus and program the various options follow the instructions showed on the display.

- 1- Select the standard; Portuguese, Spanish with 1 group or Spanish with 2 groups.
- 2- Select the type of gas for the group, CO or NO₂, Ventilation level 1, *Ventilation level 2, Alarm level, Ventilation activation delay and Ventilation deactivation delay.
- 3- Change engineer code.
- 4- Erase all programmed inputs and reset to default parameters.
- 5- Set events memory to zero.
- 6- Allows verifying the correct communication of all detectors connected to the line (walk test). Detectors will start with the following sequence 
- 7- Allows carrying out a sensor status test without using gas. See page 12
- 8- This menu lets you calibrate all detectors in the line, one by one. See page 11
- 9- In this menu you can verify each detector reading in real time. Specially useful to verify detector response with gas.
- 10- Exit programming.

** Only if Portuguese standard is programmed.*

 *If once inside this mode no key is pressed for 30 secs., the system will automatically exit to the initial OFF position.*

Once inside programming mode:

Press  to enter the desired menu option.

Press  to increase selection.

Press  to decrease selection.

Press  to memorize selection.

12. DURPARK CO-NO₂ DETECTOR CALIBRATION



This detector is guaranteed to stay calibrated throughout its useful life, however, if you decide to proceed with recalibration, do so in the following manner:

This operation must only be carried out by personnel with adequate training. They must possess the adequate tools and a test bottle with a gas concentration of 150ppm. A precise mixture of CO and synthetic air, for the calibration of CO, or a bottle of 10ppm, a precise mixture of NO₂ and N₂, for NO₂. If this adjustment is carried out in environments where a presence of gas is suspected, it will be necessary to use an N₂ (Nitrogen) bottle for correct zero adjustment.

Concentrations of 100-150* and 200ppm for CO and 5-10* and 15ppm for NO₂ may be chosen.

Enter calibration menu, a sequence searching for the detectors will start. When this is finished the following will show on the screen:

Detector 01 CO
Press ← ↑

Press  to choose a detector and  to proceed with its calibration.

Calibration Date
10/06/14

Select calibration date, day-month-year. This information is saved in the detector so it can be checked in factory.



Zero Adjust.
000PPM

Wait for at least a minute and, when the reading is stable press





*If the level shown on the display is greater than 20ppm an **ERROR** message will be shown and adjustments will not be possible, but the zero data of the last calibration will be maintained. If the level is correct (under 20ppm) it will be memorized and the option for gain calibration will be shown.*

Cal. Gain?
Press ← ↑

Press  to adjust the zero of the next detector or  to adjust gain.

* Chosen concentrations for this description.

Pattern Gas
150PPM /10PPM(NO2)

Press  to select your test bottle concentration, and  to start the calibration.

Measure Adjust
145PPM/8PPM(NO2)  

Circulate the gas mixture with the required flow through the calibration mask and wait at least four minutes, and when the measurement becomes stable press. 

The following will be shown,

Calculating

and when finished

Calibration OK
150PPM /10PPM(NO2)

To abort gain adjust press



To exit the calibration menu from any position, press



If the level reached is not within $\pm 20\%$ * of the expected response, **ERROR** will be shown and adjustments will not be possible, as the sensor response will not be able to be compensated with an adequate gain factor, but the data from the last calibration will be maintained.

Verify that the selected concentration corresponds to the one of the test bottle and repeat the process. If the error persists the sensor will have to be substituted.

**Maximum electronically compensable level.*

13. RECOMMENDED PATTERN GAS AND GAS FLOW FOR CALIBRATION

Detector type	Recommended pattern gas concentration	Flow ml/min
CO	150ppm	150
NO ₂	10ppm	400

14. INTERPRETATION OF THE DISPLAY IN TEST MODE FOR CO SENSORS

Sensor Test

EEEEEEEFBEEFBAAA

E shows up in the position belonging to the assigned detector number if everything is correct.

F shows up in the position belonging to the assigned detector number if there is a fault.

A shows up in the position belonging to the assigned detector number if there is no detector connected, "absent".

? shows in the position belonging to an NO₂ detector.



In the example above, the sensors of detectors 1-2-3-4-5-6-7 are correct, number 8 has a fault, 9-10-11 are correct, 12 has a fault, 13-14 are correct and in 15-16 there is no detector connected (Absent).

Led alternates fast, green-red, during verification time.

To verify the status of the CO detectors in the Installation once the test has finished, search for:



Only after carrying out a sensor life test, this indicates the sensor is at the end of its useful life or in bad condition. Substitute it as soon as possible with a new one.

Fixed green:



Only after carrying out a sensor life test, this indicates the sensor is in good condition.



In the NO2 detectors the led will stay turned off.

Test is designed to be used sporadically. Do not abuse this test. It may damage the sensor.

To exit this mode press and all indicators will turn off and go to normal mode.

15. DETECTOR TEST

Enter engineer mode, advance up to menú 9 and press , it will search and identify the type of detectors installed, when finished it will show:

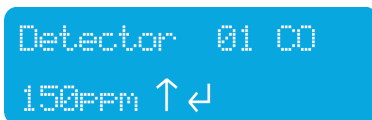

Press to go to the next one and to exit this mode.

The result of this test in the detector will be shown by the led codes.

Green intermittent -detector OK.

Red and green alternating -detector is defective, in this case an ERROR message will

briefly show in the display unit.

16. MODULE LINE START-UP

Press



and this will show up:

Code User

2222 (default setting).

Detector 2H

###

First, look for 2-wire detectors.

Detector 3H

xxx

If you can't find any, look for 3-wire detectors.

Detector 01 CO

Shows sequentially the number assigned to the detectors and the gas type.

Groups Number

01

Shows number of groups programmed or detected.

Regulation

Spa. 1 Group

Informs about the programmed standard and its version.

Battery OK

Shows battery state if equipped with one. If not "No battery" shows up.

If an error is detected, because the programming did not coincide with the installation or because of some error in the cabling, the display will show **ERROR**, the zone will disconnect and the fault led will light up, indicating if the error happens because the detectors or the groups have been wrongly configured. Review the programming, detector addressing, make sure the two gases have not been included in the same group, check the line cabling and try again.

17. DISPLAY INFORMATION WITH A CONNECTED MODULE LINE

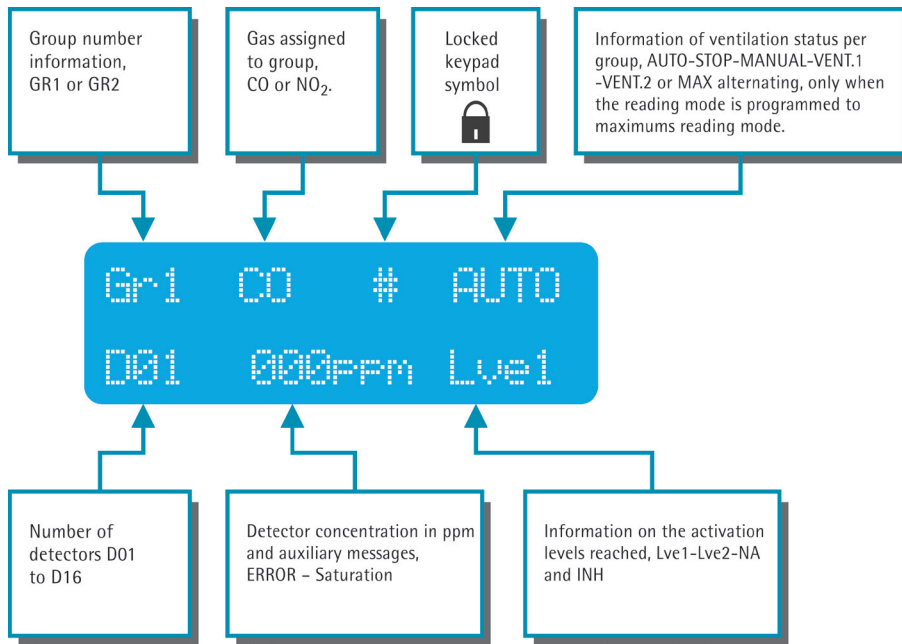

When Spanish standard and one group are programmed, both ventilation relays will activate at the same time.

Factory programming by default is for Spanish standard and for CO. If at the time of connection 2 correctly formed groups are detected, detectors 1 to 8 of one gas and 9 to 16 of another, the control panel automatically reprograms to 2 groups Spanish standard.

Unless Portuguese standard is programmed, the option for programming a second ventilation level, and its corresponding messages during the normal functioning of the module line will not show.

18. DETECTOR LED CODES

Led alternating between green and red:



Initializing. The detector still has not been recognized by the module line after being turned on. It also indicates a communication error, when the detector has not communicated with the line for more than 2 minutes.

Continous red:



CO DETECTORS, indicates that CO concentration detected is 50ppm or more.
 NO₂ DETECTORS, indicates that NO₂ concentration detected is 3ppm or more.
 This happens independently of the detection levels programmed in the module line.

Red, fast intermittent:





Not calibrated or wrongly calibrated detector.



Green sequential blinking every time detector communicated with the module line:





Correct functioning

19. MODULE LINE LED INFORMATION

Led   illuminates to indicate that the module line internal acoustics are inhibited.

Led   illuminates to indicate any kind of fault in the module line. It will reposition automatically when the cause generating it disappears.

Led   illuminates intermittently when the programmed ventilation level for the module line is reached, and continuously to indicate the activation on any of the group ventilations, it will turn off when the ventilation is disconnected, or the gas level descends.

20. KEYPAD FUNCTIONS WITH A CONNECTED MODULE LINE. (USER MODE)

Each time that the keypad is used after the  symbol shows on the display, the 2222(default setting) code must be typed in.

By pressing  the user programming mode is entered.

Once inside, the sequence to move and choose from the various menus is:

Select the menu you need with  or  press  to enter.

In this mode the menus are organized as below:

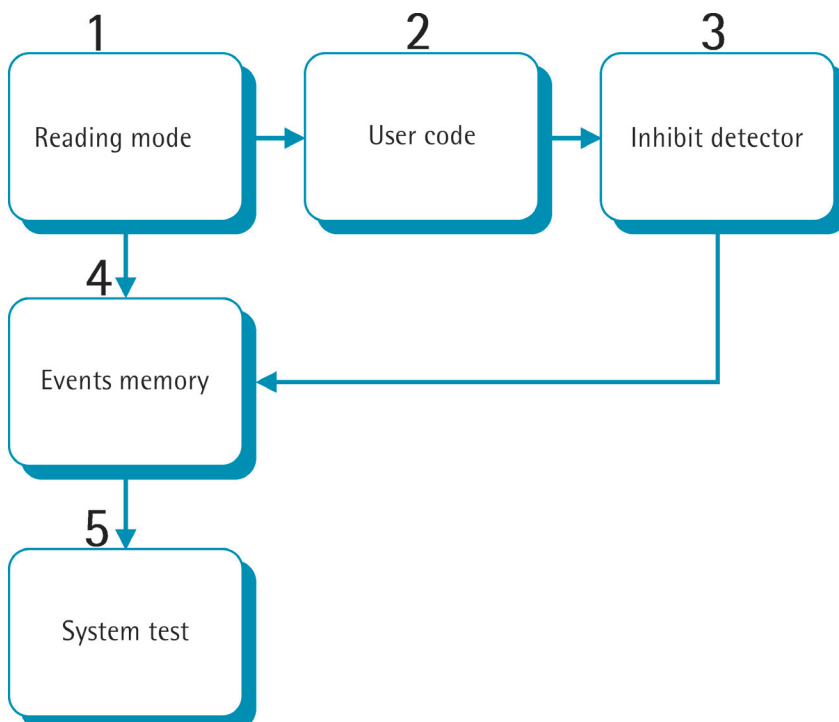

1.- Select between sequential and maximums reading modes. In maximums mode the module line display will show the detector detecting the highest gas concentration in each group, or the detector with the lowest assigned number in the group, if all indicate the same gas concentration, for instance 000ppm.

2.- User code change, allows the operator to change the access code for this menu.

3.- It allows the inhibition of detectors that are causing problems because of malfunction or decalibration.



Press



to change its

status between ACT or INH.

To exit, press



4.- Visualize 14 different types of events indicating how many times each one has occurred, up to 999 times per event. Once inside, the last registered event shows up, how many times it has occurred and the description. When its maximum capacity is reached the first saved event is substituted by the most recent.

You will be able to see how many times the following incidences took place:

- Connections.
- Disconnections.
- Power grid fault.
- Battery fault.
- Power supply source fail.
- Detector error.

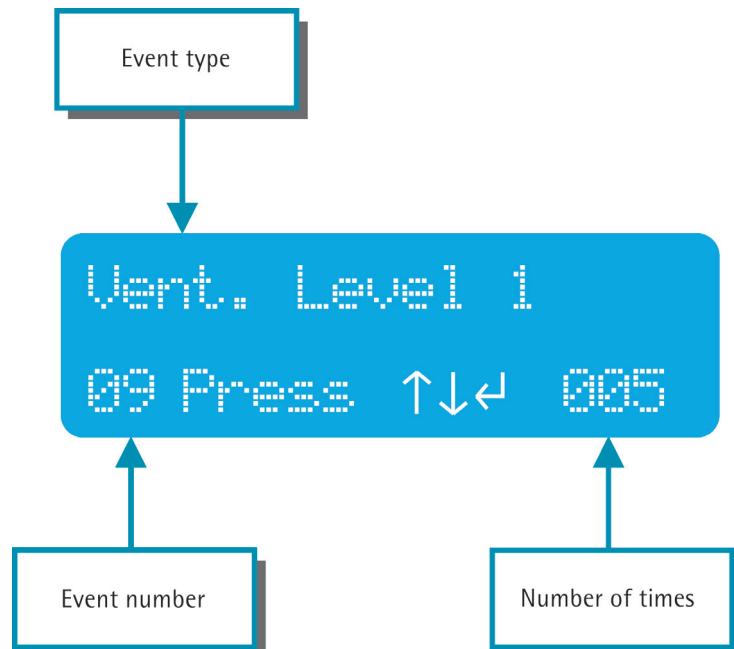

Ventilation level 1.

Ventilation level 2.

Alarm level.

Saturation level.

Ventilation 1, when activated according to programmed level.

Ventilation 2, when activated according to programmed level.

Entry into user programming mode.

Entry into engineer programming mode.



To exit press 



5.- System test, which carries out a test of the internal acoustics , optical indicators, verify the programmed standard, Ventilation 1 output, ventilation 2 output, alarm relay, power supply source tension and battery status. The system will exit to the normal reading mode of the module line automatically after the test is finished.

21. CHANGE OF VENTILATION MODE

Press  and will ask for user code, 2222 (factory default)

 blinking group number is shown. Select-

-with  or  the group you want. If there is more than one, press  select-

-with  or  between AUTO-STOP-MANUAL and confirm with 

22. ACOUSTICS INHIBITION

To inhibit acoustics, press  and the pertinent led will turn on and stay in this state until manually rearmed. In this state acoustics will only sound if there is any type of fault in the line.

23. MODULE LINE BEHAVIOUR IN CASE OF POWER FAILURE

1.- In case of power failure, if a battery was not installed, the module line will disconnect. When power is restored it will connect automatically with all the parameters that were programmed before the power failure.

2.- If a battery is installed, the module lines will tone down the lights to save energy. When the battery gets to 9V the module line will automatically disconnect.



DURPARK U01 OFF
Low Battery

Module line reconnection will be performed as above.

24. MODULE LINE TECHNICAL CHARACTERISTICS

Technology	8 bits microprocessor
Power supply	9V to 15V DC
Maximum consumption	122 mA
Line maximum length (recommended)	Up to 400/500*m. 2 wire 3 x 1.5*mm ² communications and power
Maximum number of detectors per module line	Up to 16 detectors including CO and NO ₂ simultaneously
Programmable reading modes	Sequential or maximums per group
Data presentation per module line	16 x 2 lines of alphanumeric characters backlit LCD display + 3 leds
Reading speed	3s per detector –sequential mode- and 3s in total for maximums reading mode
Outputs	3 independent per module line, 3A 250V AC dry contact fuse protected. 1 for line power supply 12V 3A, protected with automatic reset fuse and 1 for battery 12V DC 7,5 Ah, fuse protected. 12V DC 3,3Ah in the DURPARK Mini one module line version
General fault output	1 Potential-free contact C, NC on standby
Switched power source	13,8V 3.4A. DURPARK 1 to 4 module lines / 13.8V 1.6A DURPARK Mini 1 module line
Mains input	120-240V AC, 47-63Hz. 10W DURPARK 4 module lines 3W DURPARK Mini 1 module line
Cabinet dimensions, in mm	390x290x125 DURPARK 1-4 module line control panel. 280x213x83 DURPARK Mini 1 module line.
Weight –Kg-	6 Kg. DURPARK modular control panel from 1 to 4 module lines (150gr. per additional module line). 3 Kg. DURPARK Mini 1 module line.
Protection grade	IP30



**Power supply cables cross section and maximum distances change depending on the quality of the cable employed, total consumption of the detectors connected and their distribution throughout total cable length.*

25. DURPARK CO-NO₂, 3-WIRE DETECTOR, TECHNICAL CHARACTERISTICS

Technology	Microprocessor and electrochemical sensor
Power supply tension	V to 15V DC
Consumption	14mA (standby) 24mA (alarm)
Measuring range	From 0 to 300ppm CO, and 0-20ppm NO ₂
Resolution	±1ppm CO, ±0.5ppm NO ₂
Repeatability	±1% and 3% respectively
Linearity	Linear throughout its full scale
Calibration gas and recommended concentration	Precise mixture 150ppm CO + N ₂ 150ml/min Precise mixture 10ppm NO ₂ + N ₂ 400ml/min
Sensor useful life	>5 years for CO and 3 years for NO ₂ . In normal working conditions
Recalibration periods	Calibration for life
Relative humidity	From 5% to 90% RH, without condensation
Atmospheric pressure	±10%
Operational temperature	-10°C to +60°C
T90 response time	<90 s CO and <30 s NO ₂
Parallel communication	2 wires, own addressable protocol (1 to 16)
Protection grade	IP20
Materials	ABS
Weight (gr) and measurements, diameter/height (mm)	146 84,90 X 42 without base / 90 X 74 with base
Installation height	1.8 / 2 m from floor CO and 40/50 cm from floor NO ₂
Approximate coverage	200 m ² CO (following current standards) 100 m ² NO ₂ . (Recommended)

Typical operational conditions 20% O₂, 20°C ±2°C and 40%RH ±10 %RH (minimum of O₂ 10%)



IMPORTANT, CO DETECTORS:



Do not expose the detector to high concentrations of ammonia (NH₃), or to places where concentrations of Hydrogen Sulfide (H₂S) might form, as these will irreversibly damage the sensor.



Do not expose the detector to organic vapors, such as alcohols, acetones or volatile oils. Exposure may cause temporary drifts in sensor response.



Do not expose the detectors to temperatures above 60°C, as sensor may be irreversibly deteriorated.



Do not expose the detector to silicone vapors, as this may damage the sensor.



High condensation inside the detector due to a sharp temperature change may cause the sensor to behave erratically.

26. DURPARK DETECTORS GENERAL CONNECTIONS. 2 WIRE

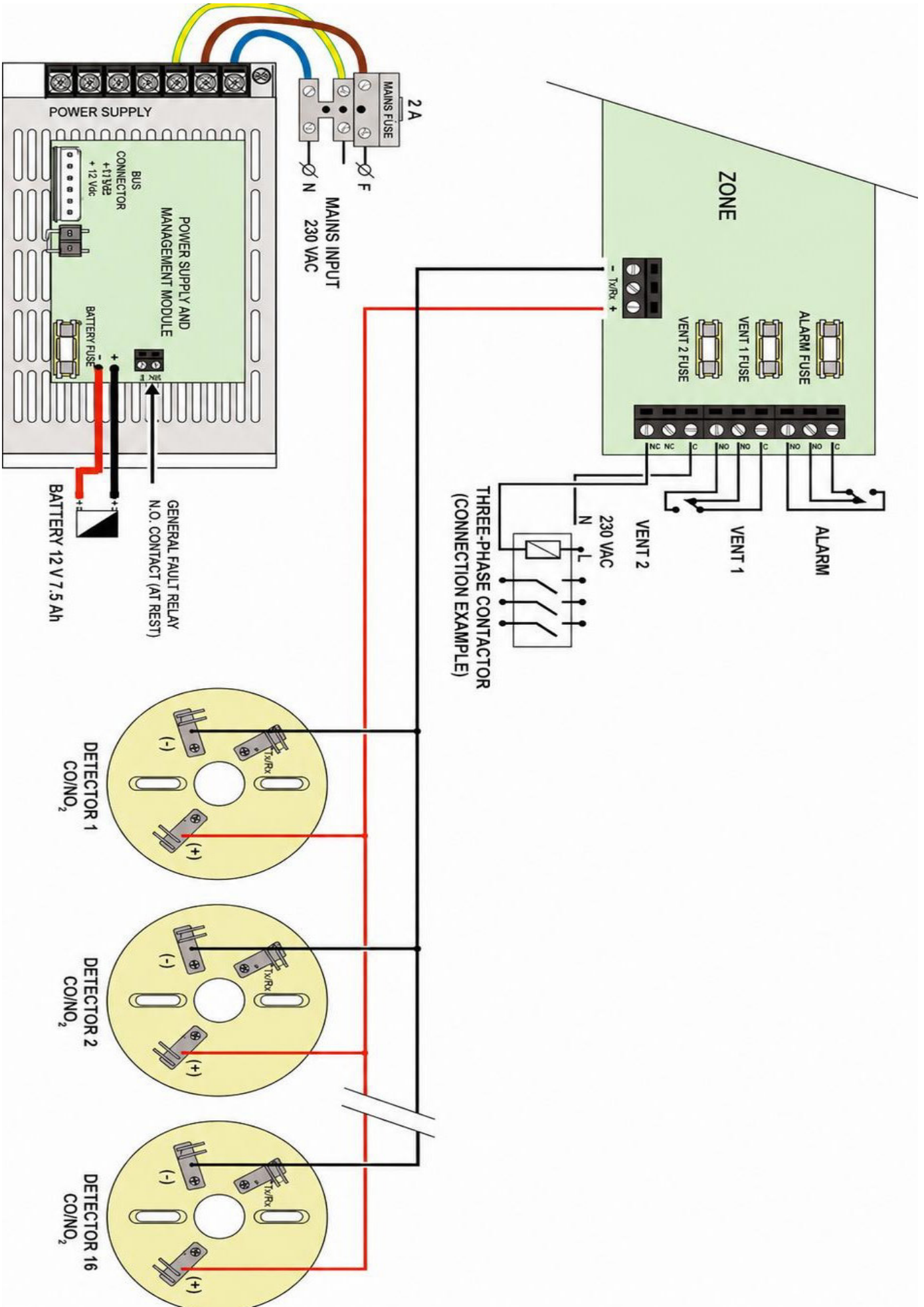

27. PARALLEL CONNECTION OF CO AND NO2 RELAYS TO A SINGLE ACTUATION

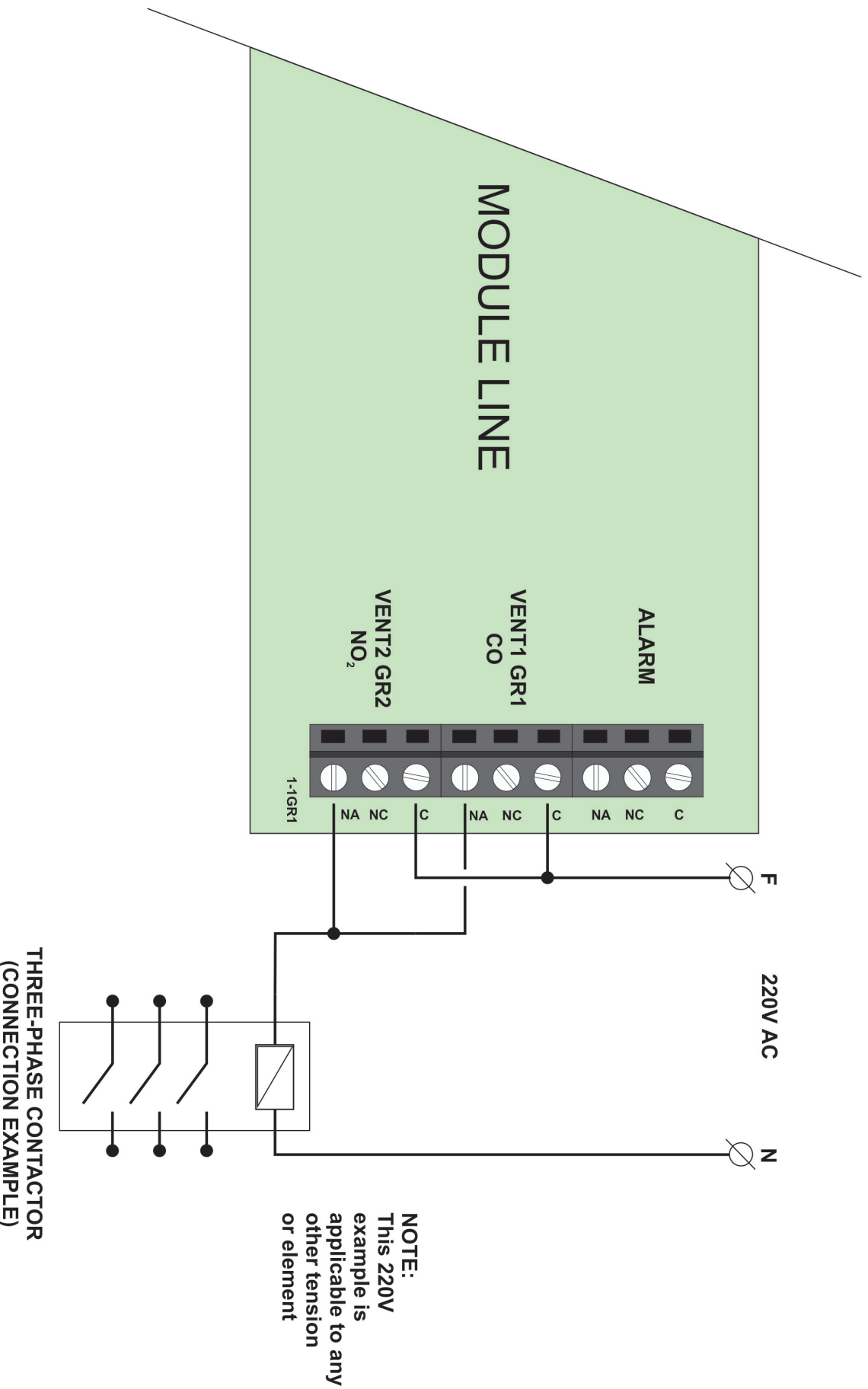

28. WARRANTY

DURAN ELECTRONICA S.L guarantees that the DURPARK Control Unit has been manufactured subject to strict quality controls.

DURPARK and its variants are guaranteed against any manufacturing defect for 1 year from the date of purchase. If during this period of time any anomaly were to be detected, please let your supplier or installer know. The warranty covers the complete repair of the equipment that DURAN ELECTRONICA S.L technical services consider to be defective, so as to return the equipment to its normal use. This warranty will be valid if the equipment has been installed by a competent person and following the specifications in this manual. Negligent use or installation will exempt DURAN ELECTRONICA S.L from responsibilities for damages caused to property and/or people and from the fulfillment of the terms of this warranty.

The warranty does not cover:

- Installations, periodical checks, maintenance and sensors past their useful life.
- Breakdowns caused by improper handling, inappropriate use, negligence, overload, inadequate power supply or equipment neglect, voltage shorts, defective installations and other external causes.
- Repairs or adjustments carried out by personnel not authorized by DURAN ELECTRONICA S.L.
- Equipment transport costs.

Compliant With UNE 23.300:1984 (CO) Spanish Standard. Certificate LOM 14MOGA3084.

Certificates Nr. E20/000002 (DURPARK) and E20/000003 (DURPARK MINI) from AENOR Accredited Notified Body ENAC RD. 2367/1985

DURAN ELECTRONICA reserves the right to modify the contents of this manual without prior notice.



FS82426



DURAN[®]
electrónica

c/ Tomás Bretón, 50
28045 MADRID, Spain
Tel: +34 91 528 93 75
Fax +34 91 527 58 19
duran@duranelectronica.com
www.duranelectronica.com

I-manDURPARK-v07